

SPILLSTENSILER Kveldsturnering BK Grand, 07. des 2009

♠ 732 Mappenr: 1(1)
♥ J7 Rundenr: 1
♦ 762 I (N)

♣ AQT64

♠ AKJ
♥ T865
♦ K954
♣ K9

♠ Q984
♥ 32
♦ AQJ3
♣ J87

♠ T65
♥ AKQ94
♦ T8
♣ 532

| Bord | NS | ØV | NS | ØV | NS | ØV |
|------|----|----|--------|-----|-----|----------|
| 2 | 11 | 2 | 2Spar | Ø 8 | 110 | 4,0 -4,0 |
| 5 | 8 | 5 | 3Ruter | Ø 9 | 110 | 4,0 -4,0 |
| 4 | 9 | 4 | 1Spar | Ø 9 | 140 | 0,0 0,0 |
| 6 | 7 | 6 | 2Spar | Ø 9 | 140 | 0,0 0,0 |
| 3 | 3 | 10 | 1NT | V 9 | 150 | -3,0 3,0 |
| 1 | 12 | 1 | 3NT | V 9 | 400 | -5,0 5,0 |

♠ KJT73 Mappenr: 2(2)
♥ 9864 Rundenr: 1
♦ A8 NS (Ø)

♣ AJ

♠ 86
♥ 32
♦ QT2
♣ T98432

♠ A52
♥ AJ7
♦ K743
♣ KQ5

♠ Q94
♥ KQT5
♦ J965
♣ 76

| Bord | NS | ØV | NS | ØV | NS | ØV |
|------|----|----|----------|-----|-----|----------|
| 6 | 7 | 6 | 2Spar | N 9 | 140 | 5,0 -5,0 |
| 1 | 12 | 1 | 2Spar | N 8 | 110 | 3,0 -3,0 |
| 5 | 8 | 5 | 3NT | Ø 7 | 100 | 1,0 -1,0 |
| 2 | 11 | 2 | 2NT | Ø 7 | 50 | -2,0 2,0 |
| 4 | 9 | 4 | 4Klover | V 9 | 50 | -2,0 2,0 |
| 3 | 3 | 10 | 4Hjarter | S 9 | 100 | -5,0 5,0 |

♠ AQ98 Mappenr: 3(3)
♥ 3 Rundenr: 1
♦ Q76 ØV (S)

♣ J9743

♠ KT643
♥ QJT75
♦ T2
♣ Q

♠ J52
♥ AK6
♦ J85
♣ AT52

♠ 7
♥ 9842
♦ AK943
♣ K86

| Bord | NS | ØV | NS | ØV | NS | ØV |
|------|----|----|---------|--------|-----|----------|
| 1 | 12 | 1 | 4Ruter | D S 11 | 610 | 5,0 -5,0 |
| 5 | 8 | 5 | 2Klover | D N 10 | 380 | 3,0 -3,0 |
| 4 | 9 | 4 | 2Spar | V 7 | 100 | -2,0 2,0 |
| 6 | 7 | 6 | 3Spar | V 8 | 100 | -2,0 2,0 |
| 3 | 3 | 10 | 3Spar | V 8 | 100 | -2,0 2,0 |
| 2 | 11 | 2 | 3Spar | V 8 | 100 | -2,0 2,0 |

♠ KT97 Mappenr: 4(4)
♥ J4 Rundenr: 2
♦ J974 A (V)

♣ K74

♠ J8
♥ KT92
♦ K3
♣ J9863

♠ Q52
♥ 86
♦ T865
♣ QT52

♠ A643
♥ AQ753
♦ AQ2
♣ A

| Bord | NS | ØV | NS | ØV | NS | ØV |
|------|----|----|-------|--------|-----|----------|
| 1 | 12 | 2 | 3NT | S 10 | 630 | 5,0 -5,0 |
| 5 | 9 | 6 | 4Spar | N 10 | 620 | 1,0 -1,0 |
| 4 | 10 | 5 | 4Spar | N 10 | 620 | 1,0 -1,0 |
| 2 | 1 | 3 | 4Spar | N 10 | 620 | 1,0 -1,0 |
| 6 | 8 | 7 | 3NT | N 8 | 100 | -3,0 3,0 |
| 3 | 4 | 11 | 6Spar | D N 10 | 500 | -5,0 5,0 |

♠ KT Mappenr: 5(5)
♥ T754 Rundenr: 2
♦ KQ76 NS (N)

♣ KT4

♠ 9762
♥ AKJ2
♦ T842
♣ 6

♠ AQ53
♥ 6
♦ AJ9
♣ A8532

♠ J84
♥ Q983
♦ 53
♣ QJ97

| Bord | NS | ØV | NS | ØV | NS | ØV |
|------|----|----|-------|------|-----|----------|
| 4 | 10 | 5 | 1Spar | Ø 10 | 170 | 4,0 -4,0 |
| 6 | 8 | 7 | 2Spar | V 10 | 170 | 4,0 -4,0 |
| 5 | 9 | 6 | 4Spar | Ø 10 | 420 | -1,0 1,0 |
| 3 | 4 | 11 | 4Spar | Ø 10 | 420 | -1,0 1,0 |
| 2 | 1 | 3 | 4Spar | Ø 10 | 420 | -1,0 1,0 |
| 1 | 12 | 2 | 4Spar | Ø 11 | 450 | -5,0 5,0 |

♠ Q985 Mappenr: 6(6)
♥ T542 Rundenr: 2
♦ J75 ØV (Ø)

♣ 64

♠ 4
♥ 6
♦ AKQ9832
♣ AKT9

♠ AT73
♥ Q7
♦ 64
♣ QJ832

♠ KJ62
♥ AKJ983
♦ T
♣ 75

| Bord | NS | ØV | NS | ØV | NS | ØV |
|------|----|----|----------|--------|------|----------|
| 3 | 4 | 11 | 4Ruter | V 13 | 190 | 5,0 -5,0 |
| 2 | 1 | 3 | 5Hjarter | D S 9 | 300 | 3,0 -3,0 |
| 4 | 10 | 5 | 5Hjarter | D S 8 | 500 | 1,0 -1,0 |
| 6 | 8 | 7 | 5Ruter | V 12 | 620 | -2,0 2,0 |
| 5 | 9 | 6 | 5Ruter | V 12 | 620 | -2,0 2,0 |
| 1 | 12 | 2 | 6Klover | D V 12 | 1540 | -5,0 5,0 |

♠ J9 Mappenr: 7(7)
♥ A9 Rundenr: 3
♦ AKJ862 A (S)

♣ 876

♠ A83
♥ K8432
♦ T74
♣ Q4

♠ K74
♥ T765
♦ Q95
♣ KT2

♠ QT652
♥ QJ
♦ 3
♣ AJ953

| Bord | NS | ØV | NS | ØV | NS | ØV |
|------|----|----|---------|------|-----|----------|
| 2 | 2 | 4 | 3NT | S 10 | 630 | 5,0 -5,0 |
| 4 | 11 | 6 | 2Spar | S 10 | 170 | 3,0 -3,0 |
| 6 | 9 | 8 | 2Spar | S 9 | 140 | 1,0 -1,0 |
| 1 | 12 | 3 | 4Klover | S 10 | 130 | -1,0 1,0 |
| 5 | 10 | 7 | 3NT | N 7 | 200 | -4,0 4,0 |
| 3 | 5 | 1 | 3NT | N 7 | 200 | -4,0 4,0 |

♠ T985 Mappenr: 8(8)
♥ KJ Rundenr: 3
♦ J97 I (V)

♣ J843

♠ KJ2
♥ A42
♦ AQT3
♣ AQ6

♠ 74
♥ Q985
♦ K854
♣ K95

♠ AQ63
♥ T763
♦ 62
♣ T72

| Bord | NS | ØV | NS | ØV | NS | ØV |
|------|----|----|-----|------|-----|----------|
| 6 | 9 | 8 | 3NT | V 9 | 400 | 5,0 -5,0 |
| 5 | 10 | 7 | 3NT | V 10 | 430 | 3,0 -3,0 |
| 4 | 11 | 6 | 3NT | V 11 | 460 | -2,0 2,0 |
| 3 | 5 | 1 | 3NT | V 11 | 460 | -2,0 2,0 |
| 2 | 2 | 4 | 3NT | V 11 | 460 | -2,0 2,0 |
| 1 | 12 | 3 | 3NT | V 11 | 460 | -2,0 2,0 |

SPILLSTENSILER Kveldsturnering BK Grand, 07. des 2009

♠ KQ97 Mappenr: 9(9)
♥ QJ9853 Rundenr: 3
♦ 9 ØV (N)
♣ K2

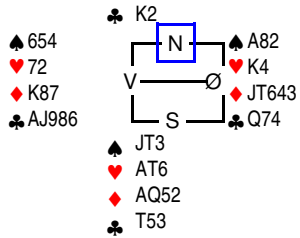

| Bord | NS | ØV | | NS | ØV | NS | ØV |
|------|----|----|----------|------|-----|------|------|
| 6 | 9 | 8 | 4Hjarter | N 11 | 450 | 3,0 | -3,0 |
| 5 | 10 | 7 | 4Hjarter | N 11 | 450 | 3,0 | -3,0 |
| 4 | 11 | 6 | 4Hjarter | N 11 | 450 | 3,0 | -3,0 |
| 2 | 2 | 4 | 4Hjarter | N 10 | 420 | -2,0 | 2,0 |
| 3 | 5 | 1 | 4Spar | N 10 | 420 | -2,0 | 2,0 |
| 1 | 12 | 3 | Pass | | | -5,0 | 5,0 |

♠ 954 Mappenr: 10(10)
♥ A952 Rundenr: 4
♦ JT A (Ø)
♣ QJ92

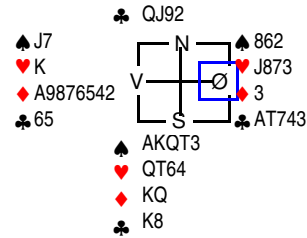

| Bord | NS | ØV | | NS | ØV | NS | ØV |
|------|----|----|----------|------|-----|------|------|
| 1 | 12 | 4 | 3NT | S 12 | 690 | 5,0 | -5,0 |
| 3 | 6 | 2 | 4Hjarter | S 10 | 620 | 1,0 | -1,0 |
| 2 | 3 | 5 | 4Spar | S 10 | 620 | 1,0 | -1,0 |
| 4 | 1 | 7 | 6Hjarter | N 10 | 620 | 1,0 | -1,0 |
| 6 | 10 | 9 | 3Spar | S 9 | 140 | -3,0 | 3,0 |
| 5 | 11 | 8 | 4Spar | S 9 | 100 | -5,0 | 5,0 |

♠ KQJ987 Mappenr: 11(11)
♥ K9 Rundenr: 4
♦ AK6 I (S)
♣ J9

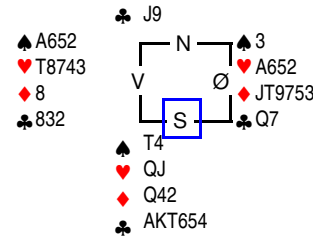

| Bord | NS | ØV | | NS | ØV | NS | ØV |
|------|----|----|---------|------|-----|------|------|
| 4 | 1 | 7 | 5Spar | N 11 | 450 | 4,0 | -4,0 |
| 3 | 6 | 2 | 5Spar | N 11 | 450 | 4,0 | -4,0 |
| 5 | 11 | 8 | 4Spar | N 10 | 420 | 1,0 | -1,0 |
| 1 | 12 | 4 | 4Klover | S 10 | 130 | -1,0 | 1,0 |
| 2 | 3 | 5 | 6Klover | S 11 | 50 | -3,0 | 3,0 |
| 6 | 10 | 9 | 6Spar | N 10 | 100 | -5,0 | 5,0 |

♠ J876 Mappenr: 12(12)
♥ AKQJ54 Rundenr: 4
♦ T4 NS (V)
♣ 4

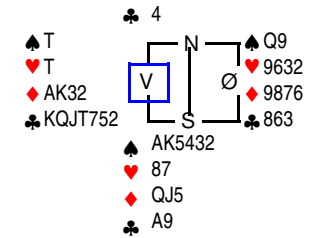

| Bord | NS | ØV | | NS | ØV | NS | ØV |
|------|----|----|---------|--------|-----|------|------|
| 1 | 12 | 4 | 3NT | S 11 | 660 | 5,0 | -5,0 |
| 4 | 1 | 7 | 5Spar | S 11 | 650 | 3,0 | -3,0 |
| 6 | 10 | 9 | 6Klover | D V 9 | 500 | 1,0 | -1,0 |
| 3 | 6 | 2 | 5Ruter | D V 9 | 300 | -1,0 | 1,0 |
| 5 | 11 | 8 | 6Spar | S 11 | 100 | -3,0 | 3,0 |
| 2 | 3 | 5 | 6Spar | D S 11 | 200 | -5,0 | 5,0 |

♠ AQJ9873 Mappenr: 13(13)
♥ K62 Rundenr: 5
♦ 972 A (N)
♣

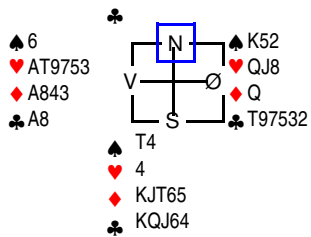

| Bord | NS | ØV | | NS | ØV | NS | ØV |
|------|----|----|-------|-------|-----|------|------|
| 4 | 2 | 8 | 4Spar | N 11 | 650 | 5,0 | -5,0 |
| 3 | 7 | 3 | 4Spar | N 10 | 620 | 2,0 | -2,0 |
| 2 | 4 | 6 | 4Spar | N 10 | 620 | 2,0 | -2,0 |
| 6 | 11 | 10 | 4Spar | N 9 | 100 | -1,0 | 1,0 |
| 5 | 1 | 9 | 4Spar | D N 9 | 200 | -4,0 | 4,0 |
| 1 | 12 | 5 | 4Spar | D N 9 | 200 | -4,0 | 4,0 |

♠ QJT6 Mappenr: 14(14)
♥ 952 Rundenr: 5
♦ 764 I (Ø)
♣ A32

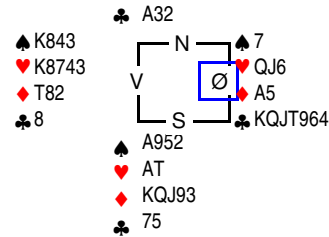

| Bord | NS | ØV | | NS | ØV | NS | ØV |
|------|----|----|----------|-------|-----|------|------|
| 1 | 12 | 5 | 5Klover | D Ø 9 | 300 | 5,0 | -5,0 |
| 4 | 2 | 8 | 5Ruter | V 9 | 100 | 3,0 | -3,0 |
| 6 | 11 | 10 | 4Hjarter | V 9 | 50 | 0,0 | 0,0 |
| 3 | 7 | 3 | 4Klover | Ø 9 | 50 | 0,0 | 0,0 |
| 2 | 4 | 6 | 3Spar | N 8 | 50 | -3,0 | 3,0 |
| 5 | 1 | 9 | 4Klover | Ø 10 | 130 | -5,0 | 5,0 |

♠ AKT975 Mappenr: 15(15)
♥ T4 Rundenr: 5
♦ KT4 NS (S)
♣ 32

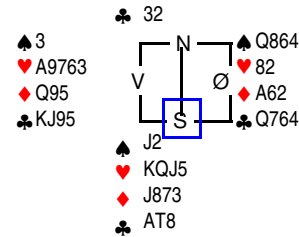

| Bord | NS | ØV | | NS | ØV | NS | ØV |
|------|----|----|-------|------|-----|------|------|
| 6 | 11 | 10 | 2Spar | N 10 | 170 | 4,0 | -4,0 |
| 3 | 7 | 3 | 3Spar | N 10 | 170 | 4,0 | -4,0 |
| 4 | 2 | 8 | 3Spar | N 9 | 140 | 1,0 | -1,0 |
| 1 | 12 | 5 | Pass | | | -1,0 | 1,0 |
| 5 | 1 | 9 | 3NT | S 6 | 300 | -4,0 | 4,0 |
| 2 | 4 | 6 | 4Spar | N 7 | 300 | -4,0 | 4,0 |

♠ A72 Mappenr: 16(16)
♥ K643 Rundenr: 6
♦ AT532 ØV (V)
♣ T

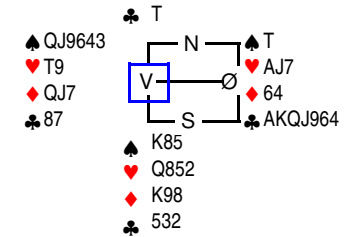

| Bord | NS | ØV | | NS | ØV | NS | ØV |
|------|----|----|---------|-------|-----|------|------|
| 5 | 2 | 10 | 5Klover | D Ø 9 | 500 | 5,0 | -5,0 |
| 3 | 8 | 4 | 5Klover | Ø 10 | 100 | 3,0 | -3,0 |
| 2 | 5 | 7 | 4Ruter | N 7 | 150 | 1,0 | -1,0 |
| 6 | 1 | 11 | 3NT | Ø 9 | 600 | -3,0 | 3,0 |
| 4 | 3 | 9 | 3NT | Ø 9 | 600 | -3,0 | 3,0 |
| 1 | 12 | 6 | 3NT | Ø 9 | 600 | -3,0 | 3,0 |

SPILLSTENSILER Kveldsturnering BK Grand, 07. des 2009

♠ K9 Mappen: 17(17)
 ♥ KQT96 Runden: 6
 ♦ KJ2 I (N)
 ♣ K74

♠ A764
 ♥ A843
 ♦ QT
 ♣ T62

♠ QJ52
 ♥ J75
 ♦ 9854
 ♣ AJ

♠ T83
 ♥ 2
 ♦ A763
 ♣ Q9853

| Bord | NS | ØV | | NS | ØV | NS | ØV |
|------|----|----|----------|-----|-----|------|------|
| 2 | 5 | 7 | 1Hjarter | N 9 | 140 | 5,0 | -5,0 |
| 3 | 8 | 4 | 2Ruter | N 9 | 110 | 3,0 | -3,0 |
| 6 | 1 | 11 | 2Spar | Ø 6 | 100 | 1,0 | -1,0 |
| 5 | 2 | 10 | 2NT | N 7 | 50 | -1,0 | 1,0 |
| 4 | 3 | 9 | 1NT | N 5 | 100 | -4,0 | 4,0 |
| 1 | 12 | 6 | 2NT | S 6 | 100 | -4,0 | 4,0 |

♠ K74 Mappen: 18(18)
 ♥ JT42 Runden: 6
 ♦ J94 NS (Ø)
 ♣ QT7

♠ A86
 ♥ KQ9765
 ♦ 7
 ♣ AJ2

♠ QJ
 ♥ 8
 ♦ KT6532
 ♣ K964

♠ T9532
 ♥ A3
 ♦ AQ8
 ♣ 853

| Bord | NS | ØV | | NS | ØV | NS | ØV |
|------|----|----|----------|-------|-----|------|------|
| 1 | 12 | 6 | 3Spar | D S 9 | 730 | 5,0 | -5,0 |
| 5 | 2 | 10 | 3Hjarter | V 7 | 100 | 3,0 | -3,0 |
| 3 | 8 | 4 | 2Spar | S 7 | 100 | 1,0 | -1,0 |
| 6 | 1 | 11 | 2Hjarter | V 9 | 140 | -3,0 | 3,0 |
| 2 | 5 | 7 | 2Hjarter | V 9 | 140 | -3,0 | 3,0 |
| 4 | 3 | 9 | 3Hjarter | V 9 | 140 | -3,0 | 3,0 |

♠ K95 Mappen: 19(19)
 ♥ J83 Runden: 7
 ♦ JT ØV (S)
 ♣ QT543

♠ Q32
 ♥ AKQT6
 ♦ Q8
 ♣ 976

♠ AJT74
 ♥ A97
 ♦ AKJ82
 ♣

♠ 86
 ♥ 97542
 ♦ K65432
 ♣

| Bord | NS | ØV | | NS | ØV | NS | ØV |
|------|----|----|--------|-------|------|------|------|
| 5 | 3 | 11 | 6Spar | Ø 10 | 200 | 5,0 | -5,0 |
| 3 | 9 | 5 | 6Spar | Ø 11 | 100 | 2,0 | -2,0 |
| 2 | 6 | 8 | 6Spar | Ø 11 | 100 | 2,0 | -2,0 |
| 6 | 2 | 1 | 4Spar | Ø 11 | 650 | -2,0 | 2,0 |
| 4 | 4 | 10 | 5Spar | Ø 11 | 650 | -2,0 | 2,0 |
| 1 | 12 | 7 | 5Ruter | D S 6 | 1100 | -5,0 | 5,0 |

♠ AKT Mappen: 20(20)
 ♥ A3 Runden: 7
 ♦ Q9853 A (V)
 ♣ 987

♠ QJ74
 ♥ 986
 ♦ JT7
 ♣ 652

♠ 96
 ♥ KQJT
 ♦ K64
 ♣ KQT4

♠ 8532
 ♥ 7542
 ♦ A2
 ♣ AJ3

| Bord | NS | ØV | | NS | ØV | NS | ØV |
|------|----|----|--------|-----|-----|------|------|
| 6 | 2 | 1 | 3Ruter | N 9 | 110 | 5,0 | -5,0 |
| 4 | 4 | 10 | 1NT | N 7 | 90 | 0,0 | 0,0 |
| 3 | 9 | 5 | 1NT | N 7 | 90 | 0,0 | 0,0 |
| 2 | 6 | 8 | 1NT | N 7 | 90 | 0,0 | 0,0 |
| 1 | 12 | 7 | 1NT | S 7 | 90 | 0,0 | 0,0 |
| 5 | 3 | 11 | 2Spar | S 7 | 100 | -5,0 | 5,0 |

♠ K86432 Mappen: 21(21)
 ♥ AT2 Runden: 7
 ♦ AK2 NS (N)
 ♣ 3

♠ Q85
 ♥ QJ94
 ♦ T98542
 ♣

♠ AT5
 ♥ K6
 ♦ T8753
 ♣ Q76

♠ QJ97
 ♥ J9743
 ♦ 6
 ♣ AKJ

| Bord | NS | ØV | | NS | ØV | NS | ØV |
|------|----|----|-------|------|-----|------|------|
| 3 | 9 | 5 | 4Spar | N 12 | 680 | 5,0 | -5,0 |
| 6 | 2 | 1 | 4Spar | N 11 | 650 | -1,0 | 1,0 |
| 5 | 3 | 11 | 4Spar | N 11 | 650 | -1,0 | 1,0 |
| 2 | 6 | 8 | 4Spar | N 11 | 650 | -1,0 | 1,0 |
| 1 | 12 | 7 | 4Spar | N 11 | 650 | -1,0 | 1,0 |
| 4 | 4 | 10 | 5Spar | N 11 | 650 | -1,0 | 1,0 |

♠ AK652 Mappen: 22(22)
 ♥ A54 Runden: 8
 ♦ 3 ØV (Ø)
 ♣ K943

♠ 87
 ♥ K7
 ♦ AKQT972
 ♣ 82

♠ JT3
 ♥ J9832
 ♦ J54
 ♣ J5

♠ Q94
 ♥ QT6
 ♦ 86
 ♣ AQT76

| Bord | NS | ØV | | NS | ØV | NS | ØV |
|------|----|----|-------|------|-----|------|------|
| 1 | 12 | 8 | 3NT | V 2 | 700 | 5,0 | -5,0 |
| 6 | 3 | 2 | 4Spar | N 11 | 450 | 0,0 | 0,0 |
| 5 | 4 | 1 | 4Spar | S 11 | 450 | 0,0 | 0,0 |
| 4 | 5 | 11 | 4Spar | N 11 | 450 | 0,0 | 0,0 |
| 2 | 7 | 9 | 4Spar | N 11 | 450 | 0,0 | 0,0 |
| 3 | 10 | 6 | 2Spar | N 11 | 200 | -5,0 | 5,0 |

♠ KQ92 Mappen: 23(23)
 ♥ K Runden: 8
 ♦ Q73 A (S)
 ♣ AKJ98

♠ AJT8
 ♥ J952
 ♦ T82
 ♣ 75

♠ 7654
 ♥ A73
 ♦ AK94
 ♣ 62

♠ 3
 ♥ QT864
 ♦ J65
 ♣ QT43

| Bord | NS | ØV | | NS | ØV | NS | ØV |
|------|----|----|----------|-----|-----|------|------|
| 6 | 3 | 2 | 2NT | N 9 | 150 | 4,0 | -4,0 |
| 2 | 7 | 9 | 2NT | N 9 | 150 | 4,0 | -4,0 |
| 1 | 12 | 8 | 1NT | N 8 | 120 | 1,0 | -1,0 |
| 4 | 5 | 11 | 2Hjarter | S 7 | 100 | -2,0 | 2,0 |
| 5 | 4 | 1 | 3NT | N 8 | 100 | -2,0 | 2,0 |
| 3 | 10 | 6 | 3NT | N 7 | 200 | -5,0 | 5,0 |

♠ KT74 Mappen: 24(24)
 ♥ 62 Runden: 8
 ♦ QJ986 I (V)
 ♣ K7

♠ 6
 ♥ KQT8743
 ♦ 752
 ♣ Q6

♠ AQ532
 ♥ A
 ♦ AT3
 ♣ T953

♠ J98
 ♥ J95
 ♦ K4
 ♣ AJ842

| Bord | NS | ØV | | NS | ØV | NS | ØV |
|------|----|----|----------|-------|------|------|------|
| 6 | 3 | 2 | 4Hjarter | V 9 | 50 | 4,0 | -4,0 |
| 5 | 4 | 1 | 4Hjarter | V 9 | 50 | 4,0 | -4,0 |
| 2 | 7 | 9 | 3Hjarter | V 10 | 170 | 0,0 | 0,0 |
| 1 | 12 | 8 | 3Spar | V 10 | 170 | 0,0 | 0,0 |
| 4 | 5 | 11 | 4Hjarter | V 10 | 420 | -3,0 | 3,0 |
| 3 | 10 | 6 | 5Ruter | D N 6 | 1100 | -5,0 | 5,0 |

SPILLSTENSILER Kveldsturnering BK Grand, 07. des 2009

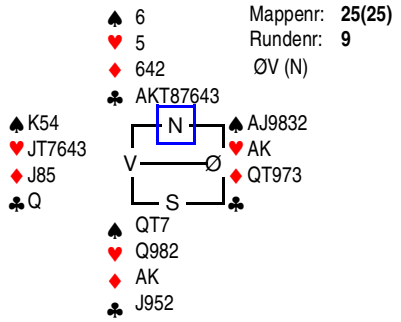

| Bord | NS | ØV | NS | ØV | NS | ØV |
|------|----|----|---------|--------|-----|----------|
| 2 | 8 | 10 | 5Kløver | D N 12 | 650 | 5,0 -5,0 |
| 1 | 12 | 9 | 5Kløver | D N 11 | 550 | 3,0 -3,0 |
| 6 | 4 | 3 | 5Spar | D Ø 10 | 200 | -1,0 1,0 |
| 5 | 5 | 2 | 5Spar | D Ø 10 | 200 | -1,0 1,0 |
| 4 | 6 | 1 | 5Spar | D Ø 10 | 200 | -1,0 1,0 |
| 3 | 11 | 7 | 4Spar | D Ø 10 | 790 | -5,0 5,0 |

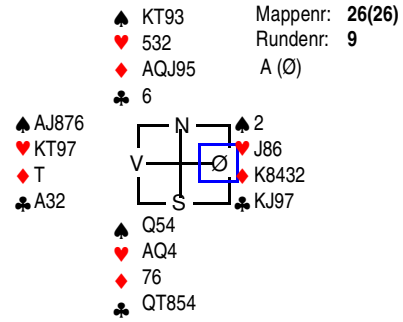

| Bord | NS | ØV | NS | ØV | NS | ØV |
|------|----|----|----------|-------|-----|----------|
| 1 | 12 | 9 | 2NT | D S 8 | 690 | 5,0 -5,0 |
| 4 | 6 | 1 | 2Hjertes | V 7 | 100 | 3,0 -3,0 |
| 2 | 8 | 10 | 2NT | N 6 | 200 | -1,0 1,0 |
| 6 | 4 | 3 | 2Ruter | N 6 | 200 | -1,0 1,0 |
| 3 | 11 | 7 | 2Ruter | N 6 | 200 | -1,0 1,0 |
| 5 | 5 | 2 | 3Ruter | N 6 | 300 | -5,0 5,0 |

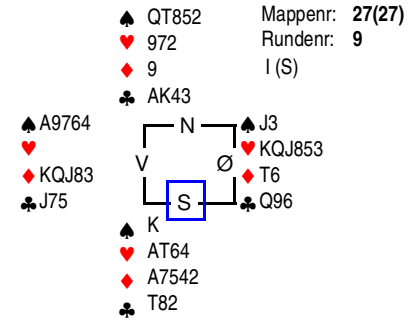

| Bord | NS | ØV | NS | ØV | NS | ØV |
|------|----|----|----------|-----|-----|----------|
| 3 | 11 | 7 | 4Spar | V 5 | 250 | 5,0 -5,0 |
| 6 | 4 | 3 | 3Hjertes | Ø 5 | 200 | 2,0 -2,0 |
| 5 | 5 | 2 | 4Spar | V 6 | 200 | 2,0 -2,0 |
| 4 | 6 | 1 | 3Spar | V 6 | 150 | -1,0 1,0 |
| 2 | 8 | 10 | 2NT | V 6 | 100 | -4,0 4,0 |
| 1 | 12 | 9 | 3Hjertes | Ø 7 | 100 | -4,0 4,0 |